

INDEX

1	DESCRIPTION OF THE APPLIANCE (see page 3)	7
2	SAFETY WARNINGS	7
3	INSTALLATION	8
4	USING FOR THE FIRST TIME	8
5	TURNING ON AND PREHEATING	9
6	PREPARING COFFEE (USING COFFEE BEANS) AND USEFUL TIPS	9
7	CHANGING THE QUANTITY OF COFFEE IN THE CUP	11
8	REGULATING THE COFFEE MILL	11
9	PREPARING ESPRESSO COFFEE WITH PRE-GROUND COFFEE (INSTEAD OF BEANS)	11
10	RUNNING OFF HOT WATER	12
11	CHANGING THE QUANTITY OF HOT WATER	12
12	PREPARING CAPPUCCINOS (FROTHED MILK AND COFFEE)	12
13	PREPARING LATTE OR FLAT WHITE	13
14	PREPARING FROTHED AND HOT MILK (WITHOUT COFFEE)	13
15	CHANGING THE QUANTITY OF COFFEE AND MILK FOR CAPPUCCINO/ LATTE/FLAT WHITE	13
16	CLEANING AND MAINTENANCE	14
16.1	CLEANING THE COFFEE MAKER	14
16.2	CLEANING THE INFUSER	14
16.3	CLEANING THE MILK CONTAINER	15
17	CHANGING AND SETTING THE MENU PARAMETERS	15
17.1	SETTING THE CLOCK	16
17.2	SETTING AUTO-START TIME	16
17.3	DESCALE	16
17.4	CHANGING COFFEE TEMPERATURE	17
17.5	CHANGING THE LENGTH OF TIME THE APPLIANCE REMAINS ON	17
17.6	SETTING WATER HARDNESS	18
17.7	RESETTING FACTORY DEFAULT SETTINGS	18
17.8	WASHING PROCESS	18
17.9	BEEP ON/OFF	18
18	CHANGING THE LANGUAGE	18
19	MEANING OF MESSAGES AND WHAT TO DO	19
20	PROBLEMS THAT CAN BE RESOLVED BEFORE CALLING THE SERVICE CENTRE	20

1 DESCRIPTION OF THE APPLIANCE (SEE PAGE 3)

- A. Main ON/OFF switch
- B. Lights
- C. Hot water spout
- D. Water tank (removable)
- E. Cup tray
- F. Drip tray (removable)
- G. Service door
- H. Coffee spout (adjustable in height)
- I. Control panel
- J. Bean container lid
- K. Central ground coffee lid
- L. Infuser
- M. Power cable
- N. Measure for pre-ground coffee
- O. Coffee grounds container (removable)
- P. Measure for pre-ground coffee
- Q. Grinding coarseness regulator
- R. Ground coffee funnel
- S. Compartment for measure
- T. Mobile drawer
- U. Accessories holder
- V. Milk container lid/milk frother
- W. Frothed milk spout
- X. Milk intake tube
- Y. Milk container handle
- Z. Hot water spout

Control Panel

A number of buttons on the panel have a double function. This is indicated in brackets in the description.

1. ON/OFF button
2. Display
3. One short coffee button
4. Two short coffees button
5. One long coffee button
6. Two long coffees button
7. One flat white button (or hot milk if pressed twice consecutively)
8. One milk with coffee button (or frothed milk if pressed twice consecutively)
9. One cappuccino button (or frothed milk if pressed twice consecutively)
10. Button to select coffee taste or preparation with pre-ground coffee. (**OK** button to confirm changes to menu settings).
11. Hot water button. (**SET** button to change menu settings)
12. Rinse button. ( button to change menu settings)
13. **P** button to enter the appliance menu. (**ESC** button to exit menu).

2 SAFETY WARNINGS

READ THESE INSTRUCTIONS CAREFULLY AND KEEP FOR FUTURE CONSULTATION!

- This appliance is designed to "make espresso coffee" and "heat drinks". Use with care to avoid scalds from the water and steam jets or through incorrect use.
- This appliance is intended for domestic use only. Any other use is considered improper and thus dangerous.
- The manufacturer cannot be held responsible for any damage caused through incorrect, wrong or unreasonable use.
- When using the appliance, do not touch the hot surfaces. Use the knobs or handles.
- Never touch the appliance with wet or damp hands or feet.
- The appliance is not intended for use by persons (including children) with reduced physical, sensory or mental capabilities, or lack of experience and knowledge, unless they have been given supervision or instruction concerning use of the appliance by a person responsible for their safety. Children should be supervised to ensure that they do not play with the appliance.
- In the event of failure or malfunction, unplug the appliance from the mains and do not tamper with it in any way. If it requires repair, contact an authorised service centre only and ask for original spare parts to be used. Failure to respect the above could reduce the safety of the appliance.
- If the power cable is damaged, it must be replaced by the manufacturer or an authorised technical service centre in order to avoid all risk.
- This appliance may be installed above a conventional built oven provided it is fitted with a cooling blower on the top side. The nominal power of the oven shall not be more than 3Kw.
- Do not rest objects containing liquids, inflammable or corrosive materials; use the accessories holder to contain coffee accessories (for example coffee measure). Do not rest big objects that may block the movement of the appliance or unstable objects.
- Materials and accessories coming into contact with food conform to EC regulation 1935/2004.

BUILDING-IN

Please check the minimum measures necessary to the proper installation of the appliance.

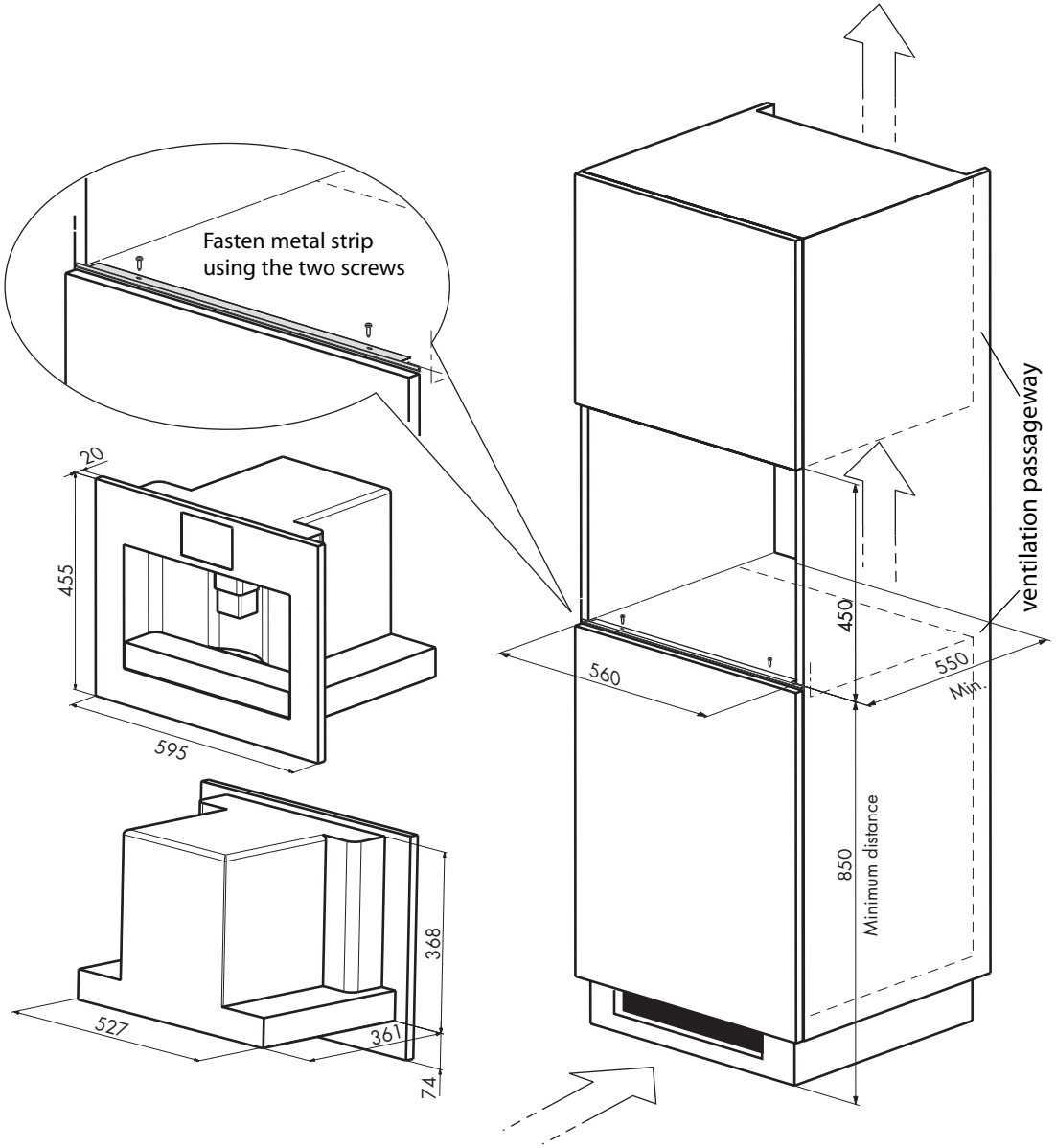

1

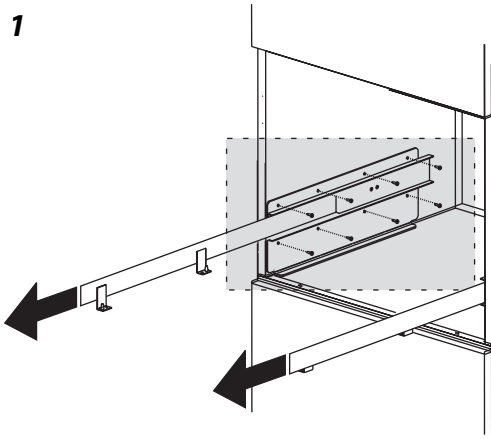

Lean the bars to the surface of the furniture.
Fix the bars with the screws provided; then completely extract the two bars.

2

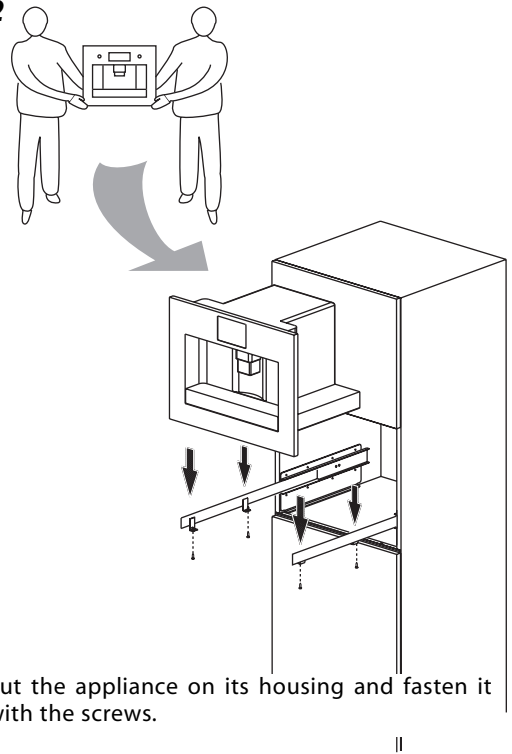

Put the appliance on its housing and fasten it with the screws.

3

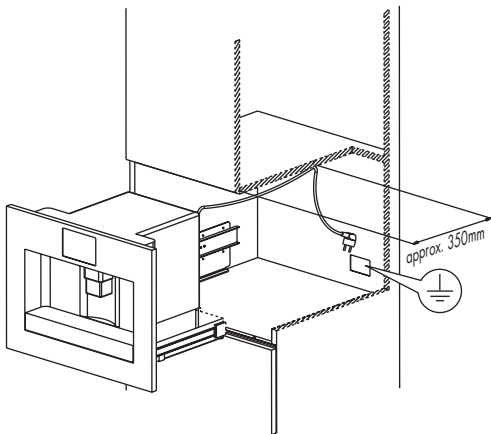

Fix the power cord with the special clip, to avoid the cord entangling when extracting or inserting the appliance.

The appliance must be connected to an earthed power socket.

4

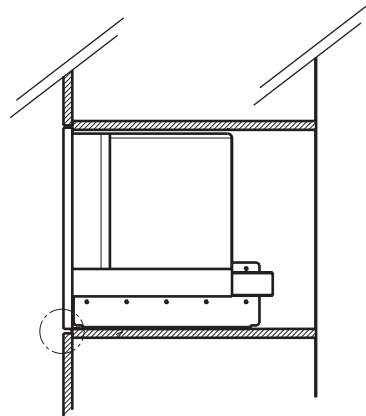

To align correctly the appliance, put the spacers under the bar's support.

3 INSTALLATION

- After unpacking, make sure the appliance is complete and undamaged. If in doubt, do not use it. Contact professionally qualified personnel.
- The packing elements (plastic bags, polystyrene foam, etc.) should be kept out of the reach of children as they are a safety hazard.
- Installation must be carried out by a qualified technician and in compliance with current regulations.
- **Never install the appliance in environments where the temperature may reach 0 or lower (the appliance may be damaged if the water freezes).**
- Make sure the mains voltage corresponds to the voltage indicated on the appliance rating plate. Connect the appliance to an efficiently earthed socket with a minimum current rating of 10A only. The manufacturer may not be considered liable for possible incidents caused by the failure to adequately earth the mains.
- If the power socket does not match the plug on the appliance, have the socket replaced with a suitable type by a qualified professional.
- The power cable on this appliance must not be replaced by the user as this operation requires the use of special tools. If the cable is damaged or requires replacing, contact an authorised service centre only to avoid all risks.
- Do not use multiple plug adapters or extension leads.
- You should personalise water hardness as soon as possible following the instructions in section 17.6.
- Coffee has been used to factory test the appliance and it is therefore completely normal for there to be traces of coffee in the grinder. It is, however, guaranteed to be new.
- The pull-out runners for securing the coffee maker to the housing are screwed to the bottom of the coffee maker with four screws.
- Remove the fixing screws and fit the runners as indicated in the instructions (paragraph BUILDING-IN); the screws are not required for installing the coffee maker.
- The appliance's rating label is positioned on the side of the coffee maker so that it remains visible after installation when the machine is removed from its housing.

To correctly learn how to use the appliance, when starting it for the first time, carefully follow the step-by-step instructions described in the following paragraphs.

4 USING FOR THE FIRST TIME

The first time you switch on the appliance and every time that it is plugged in, when you press the main ON/OFF switch (A), the appliance makes a SELF-DIAGNOSIS operation and then switches off; to turn it on, press the ON/OFF switch (2) on the control panel.

1. The first time you use the appliance, select the language.
Press the main ON/OFF switch on the rear side of the appliance; the lights on the front side and the display go on; wait for the appliance to display:

PRESS OK TO INSTALL ENGLISH

While the message is displayed, press the **OK** button (fig. 1) for at least three seconds until you hear a BEEP and the display shows:

ENGLISH INSTALLED

The appliance then displays the setting message in English. If you select the wrong language by mistake, follow the instructions in section 18 to choose the right one.

2. After 5 seconds, the appliance displays:

FILL TANK

To refill the tank, remove (fig. 2), rinse and fill it with fresh water. Never exceed the MAX line.

Put the tank back and push as far as it will go. The appliance now displays:

PRESS OK

3. Place a cup under the hot water spout (fig. 3). If the water spout is not in place, INSERT WATER SPOUT is displayed. Attach it as shown in figure 4. The appliance now displays: *PRESS OK*.
4. Press the **OK** button (fig. 1) and a little water is run off from the spout.
5. The appliance displays:

TURNING OFF PLEASE WAIT

and it goes off.

6. Extract the appliance by pulling it outwards taking care to use the special handles, open the lid and fill the container with coffee beans (fig. 5) being careful not to exceed the "MAX" line, then close the lid and push inwards the appliance.

IMPORTANT: to prevent malfunction, never fill with ground coffee, freeze dried coffee, caramelised beans or anything else which could damage the appliance.

5 TURNING ON AND PREHEATING

1. Press the  button (fig. 6). The appliance displays:

HEATING UP PLEASE WAIT

to indicate preheating is underway.

2. Once preheating is completed, the appliance displays

RINSING PLEASE WAIT

and performs an automatic rinse cycle (a little hot water is run off from the spouts and is collected in the drip tray below).

Tip: if you want short coffee (less than 60 cc), to make it hotter, fill the cup with this hot rinsing water first. Leave it for a few seconds then empty it to preheat the cup.

8. The appliance now displays the ready message:

READY STANDARD TASTE





6 PREPARING COFFEE (USING COFFEE BEANS) AND USEFUL TIPS

1. The appliance is preset to make coffee with a standard taste. You can also choose coffee with an extra-light, light, strong or extra-strong taste.

To choose the required taste, press the  /OK button (fig. 1). The selected coffee taste will be displayed.

2. Place 1 cup under the spouts to make 1 coffee (fig. 7) or 2 cups for 2 coffees (fig. 8).

For a creamier coffee, lower the spouts to bring them as close to the cups as possible (Fig. 9).

3. Press one of the coffee buttons (fig. 10): the  button to make a short coffee or the  button for a long coffee; To make 2 coffees, press the two short coffees  button or the two long coffees  button.

To change the quantity of coffee delivered automatically into the cup, follow the instructions in section 7.

(The appliance now grinds the beans and starts running off the coffee into the cup.

Once the desired quantity has been reached, the appliance automatically stops delivering the coffee and ejects the grounds into the special container).

4. After a few seconds, the ready message is displayed again and you can make another coffee.

5. To turn the appliance off, press the .

Before going off, the appliance performs an automatic rinse cycle (a little hot water runs out from the spouts and is collected in the drip tray beneath. Take care to avoid scalds).

Once switched off, the lights don't shut off immediately and the cooling span motor operates to avoid condensation into the housing. After about 30 minutes, the appliance switches completely off.

NOTE 1: If the coffee is delivered a drop at a time or not at all, with the coffee grinder in operation, turn the grinding coarseness regulator (fig. 11) one click towards the number 7 (see section 8).

Turn one click at a time until the coffee is delivered satisfactorily.

NOTE 2: If the coffee is delivered too fast and is not creamy enough, turn the grinding coarseness regulator (fig. 11) one click towards the number 1 (see section 8).

Avoid turning the grinding coarseness regulator excessively otherwise when you select 2 cups, the coffee may run out in drips.

NOTE 3: Tips to make hotter coffee:

- When **you turn the appliance on**, if you want to make a short coffee (less than 60 cc), use the hot rinse-

through water to preheat the cups.

If **2/3 minutes have passed** since you last made coffee, before making coffee again you are recommended to preheat the infuser by pressing the  button (fig. 12).

Run off the water into the underlying drip tray or alternatively use this water to fill the cup to be used for the coffee, so as to preheat it.

- Unless preheated, do not use cups that are too thick, as they will absorb too much heat.
- Use cups that have been preheated by rinsing them with hot water or by leaving them for at least 20 minutes on the cup warmer tray on top of the appliance with the appliance on.

NOTE 4: while the appliance is making the coffee, **delivery can be stopped** at any time by pressing one of the coffee buttons (fig. 10).

NOTE 5: as soon as delivery is complete, to **increase the quantity** of coffee, simply press and hold one of the coffee buttons (fig. 10), until the desired quantity is reached (this operation must be performed within 3 seconds from when coffee delivery from the spouts

NOTE 6: when the appliance displays:

FILL TANK

and emits a double "BEEP", the water tank must be refilled or the appliance will not make coffee. (It is normal for there to be a little water left in the tank when the message is displayed).

NOTE 7: every 14 single coffees (or 7 doubles) the appliance displays:

EMPTY GROUNDS CONTAINER

and emits a double "BEEP", indicating that the grounds container is full and must be emptied and cleaned. Until the grounds container has been cleaned, the appliance continues to display the message and cannot make coffee.

To clean, open the service door at the front by pulling the coffee spout (fig. 13), remove the drip tray (fig. 14), empty and clean. *When proceeding, **always completely extract the drip tray**, to avoid that it falls when removing the grounds container.*

Empty the grounds container and clean thoroughly, making sure all residues deposited on the bottom are removed.

IMPORTANT: when removing the drip tray, the grounds container **MUST** be emptied, even if it is not completely full. If this is not done, when next making coffee the grounds in the container may exceed the maximum level and block the appliance.

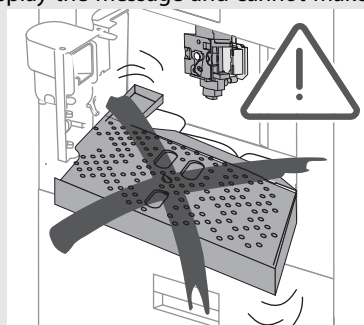

NOTE 8: while the appliance is running off coffee, never remove the water tank.

If it is removed, it will not be possible to make the coffee and the appliance will display:

GROUND TOO FINE ADJUST MILL AND INSERT WATER SPOUT AND PRESS OK

To turn the appliance on again, you must insert the hot water spout (fig. 4), press the **OK** button and run off water from the spout for a few seconds.

When using the appliance for the first time, 4-5 cups of coffee and a cappuccino need to be made before the appliance starts to give satisfying results.

If the appliance malfunctions, do not contact the service centre straight away.

The problem can almost always be resolved by following the instructions indicated in paragraphs 19 and 20.

If this is not the case, or for further explanations, contact the customer service by calling the number listed on the sheet enclosed on page 2.

If your country is not listed on the sheet, call the number indicated on the warranty.

7 CHANGING THE QUANTITY OF COFFEE IN THE CUP

The appliance is factory preset to automatically deliver the following quantities of coffee:

- two short coffees (when the ☕ button is pressed);
- long coffee (when the ☕ button is pressed);
- two short coffees (when the ☕☕ button is pressed);
- two long coffees (when the ☕☕ button is pressed); .

To change these quantities, proceed as follows:

- press the button corresponding to the quantity you want to change (☕ or ☕ or ☕☕ or ☕☕ for at least 8 seconds then release until the message "PROGRAM QUANTITY" is displayed and coffee is delivered;
- when the coffee in the cup reaches the required level, press the same button again to memorise the new amount.

The appliance emits a double "BEEP" of confirmation.

The appliance is now re-programmed with the new settings and displays: READY.

8 REGULATING THE COFFEE MILL

The coffee grinder is preset in the factory to prepare coffee correctly and should not require regulating initially. However, after making the first coffees, if you find that coffee delivery is either too fast or too slow (in drips), the grinding coarseness regulator can be adjusted (fig. 11).

Turning it 1 click (1 number) clockwise speeds up coffee delivery (without drips).

Turning it 1 click anticlockwise slows down delivery giving a creamier appearance to the coffee.

These adjustments will only be evident after at least 2 cups of coffee have been run off.

The grinding coarseness regulator must only be turned when the coffee mill is on.

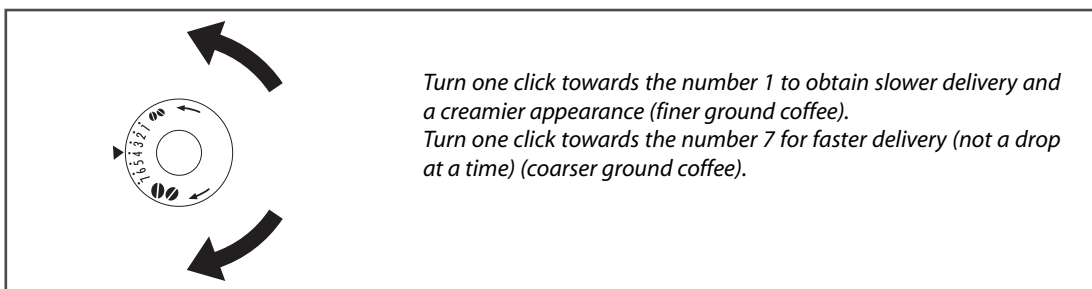

9 PREPARING ESPRESSO COFFEE WITH PRE-GROUND COFFEE (INSTEAD OF BEANS)

- Select the ground coffee function by pressing the ☕/☕/OK button (fig. 1) repeatedly until

READY - PRE-GROUND COFFEE

flashes on the display. This disables the coffee mill function.

- Lift the lid in the centre, place one level measure of ground coffee in the funnel (see fig. 15) and proceed as described in section 6. NB: NB: You can make one coffee at a time by pressing the ☕ or ☕ button.
- After using the appliance with pre-ground coffee, to go back to making coffee using beans, deactivate the ground coffee function by repressing the ☕/☕ button to prepare the grinder for operation again.

NOTE 1: Never add the ground coffee when the appliance is off to avoid it from being dispersed inside the appliance.

NOTE 2: Never add more than one level measure, otherwise either the appliance will not make the coffee and the ground coffee will be lost inside the appliance, dirtying it, or the coffee will run off in drips.



NOTE 3: When dosing the quantity of coffee to be added, use the measure supplied only.

NOTE 4: Use ground coffee for espresso coffee makers only. Do not use coffee beans, freeze-dried coffee or other materials that could damage the appliance.

NOTE 5: If you add more than one measure of ground coffee and the funnel blocks, use a knife to push the coffee down (fig. 16), then remove and clean the infuser and appliance as described in section 16.2 "Cleaning the infuser".

10 PRODUCING HOT WATER

- Always make sure the appliance is ready..
- Make sure the hot water spout is attached to the nozzle (fig. 4);
- Position a container under the spout (fig. 3).
- Press the  button (fig. 17).

The appliance displays:

HOT WATER

and hot water is run off from the water spout into the container below (you should not run off hot water for more than two minutes at a time). To stop the flow, press the  button. Once the set quantity of hot water has been reached, run-off stops automatically.

11 CHANGING THE QUANTITY OF HOT WATER

The appliance is factory preset to automatically deliver 250 ml of hot water. To change these quantities, proceed as follows:

- Make sure the water spout is in place (fig. 4).
- Position a container under the spout (fig. 3).
- Press the  button (fig. 17) for at least 8 seconds until you hear a "BEEP", then release the button.

The appliance displays:

HOT WATER PROGRAM QUANTITY

and hot water is run off from the water spout.

- When the hot water in the cup reaches the required level, press the  button to memorise the new amount. The appliance emits a double "BEEP".
(You should not run off hot water for more than two minutes at a time).

12 PREPARING CAPPUCCINOS (FROTHED MILK AND COFFEE)

- Select the taste of the coffee you want to use to make the cappuccino by pressing the **OK**  button (fig. 1).
- Remove the lid of the milk container by turning and pulling it .
- Fill the container with about 100 grams of milk for each cappuccino to be prepared (fig. 18).
Never exceed the MAX level (corresponding to about 800 ml) marked on the container.
You should preferably use skimmed or semi-skimmed milk at refrigerator temperature (about 5° C).
- Make sure the intake tube is correctly inserted in the bottom of the milk container lid (fig. 19), then replace the milk container lid and turn anticlockwise as far as it will go.
- Place the container pointer in position 1 (=CAPPUCCINO) (fig. 20). If the froth is not satisfactory, move the pointer slightly until you obtain the required froth.
- Remove the hot water spout (fig 21) and attach the milk container to the nozzle. You will hear a "BEEP" (fig. 22).
- Position the milk tube as shown in fig. 23 and then place a sufficiently large cup under the coffee and milk spouts.
- Press the CAPPUCCINO button (fig. 24).

The button lights up and the appliance displays:

CAPPUCCINO CONTAINER POINTER IN POSITION 1

Make sure the milk container lid pointer is turned to the same number as the number displayed.

After a few seconds, the frothed milk is run off from the milk spout into the cup below.

Run off of milk stops automatically and run off of coffee begins.

NOTE 1: While preparing the cappuccino, frothed milk or coffee run off can be interrupted by pressing the **CAPPUCCINO** button.

NOTE 2: If you run out of milk while delivering frothed milk, remove the container and refill it. Then put it back in place and press the **CAPPUCCINO** button to request a cappuccino again.

NOTE 3: To ensure the milk frother is absolutely clean and hygienic, after making cappuccinos, clean the channels inside the milk container lid:

- Place a recipient under the milk spout;
- Press the **CLEAN** button on the milk container lid and hold down for at least 8 seconds (fig. 25).
The appliance displays:

CLEANING

After cleaning is complete, remove the milk container and place in the refrigerator. You should not leave the milk outside the refrigerator for more than 15 minutes.

NOTE 4: To change the quantity of coffee or frothed milk delivered automatically into the cup, follow the instructions in section 15.

13 PREPARING LATTE (MILK WITH COFFEE) OR FLAT WHITE

- Prepare the appliance as described to make cappuccino.
- Before attaching the milk container to the spout, place the pointer in **position 2** if you want to make **LATTE (MILK WITH COFFEE)** or in **position 3** if you want to make **FLAT WHITE** (fig. 26). If the froth is not satisfactory, move the pointer slightly until you obtain the required froth.
- Press the **LATTE** button (fig. 27).

The button lights up and the appliance displays the message:

LATTE CONTAINER POINTER IN POSITION 2

or

- Press the **FLAT WHITE** button (fig. 28). The button lights up and the appliance displays the message:

FLAT WHITE CONTAINER POINTER IN POSITION 3

and after a few seconds, the frothed milk is run off from the milk spout into the cup below. (Run off stops automatically).

14 PREPARING FROTHED MILK AND HOT MILK (WITHOUT COFFEE)

To obtain frothed milk only without coffee or hot milk only without coffee, turn the pointer on the lid to the required position (1, 2 or 3) and then press the cappuccino, latte or flat white buttons twice (within two seconds).

15 CHANGING THE QUANTITY OF COFFEE AND MILK FOR CAPPUCCINO/LATTE/FLAT WHITE

The appliance is factory preset to automatically deliver the following quantities of coffee or milk: To change these quantities, proceed as follows:

- Fill the container with milk up to the maximum level indicated on the container.
- Press the button corresponding to the process you want to modify (**CAPPUCCINO/LATTE/FLAT WHITE**) for at least 8 seconds until the appliance emits a "BEEP" and displays:

MILK FOR... PROGRAM QUANTITY

Then release the button. The appliance starts running off milk.

- Once the required quantity of milk has been run off, press the button selected previously. Milk delivery stops and the quantity is memorised. (The appliance emits a "BEEP").
- After a few seconds, the appliance runs off coffee into the cup and displays:

COFFEE FOR... PROGRAM QUANTITY

- Once the required quantity of coffee has been run off, press the button selected previously. Coffee delivery stops and the quantity is memorised. A double "BEEP" confirms that the new values have been memorised. The appliance is now re-programmed with the new settings and displays: *READY*.

16 CLEANING AND MAINTENANCE

Before performing any cleaning operations, leave the appliance to cool down, switch off the main switch and unplug from the mains socket.

Never immerse the appliance in the water: it is an electrical appliance.

Do not use solvents, abrasive cleaning products or alcohol to clean the appliance. A soft damp cloth will suffice. No component may be washed in a dishwasher.

16.1 Cleaning the coffee maker

Clean the grounds container (as described in section 6, note 7) whenever it requires emptying.

The water tank should also be cleaned regularly.

The drip tray is fitted with a level indicator (red) showing the level of water it contains.

When the indicator starts to become visible (a few millimetres under the drip tray), the drip tray must be emptied and cleaned.

Check that the holes in the coffee spout are not blocked. To unblock them, scrape the dry coffee residues away with a needle (fig. 29).

Clean the nozzle after every use with a sponge as shown in fig. 30.

16.2 Cleaning the infuser

The infuser must be cleaned regularly to avoid the build-up of coffee encrustations which could cause malfunction. Proceed as follows:

- turn the appliance off by pressing the  button (fig. 6) (do not unplug) and wait for the display to go off;
- open the service door (Fig. 13);
- remove the drip tray and the grounds container (Fig. 14) and clean them;
- press the two red release buttons on the infuser sideways and towards the centre (Fig. 31) and pull it out;
- IMPORTANT: THE INFUSER CAN ONLY BE REMOVED IF THE APPLIANCE IS OFF.**

ATTEMPTING TO REMOVE THE INFUSER WITH THE APPLIANCE ON MAY CAUSE SERIOUS DAMAGE.

- wash the infuser under running water, without using detergents. Never wash the infuser in the dishwasher;
- carefully clean the inside of the appliance. To remove the coffee stuck to the parts inside the appliance, scrape it with a plastic or wooden fork and then pick up all the residues using a vacuum cleaner (Fig. 32);
- replace the infuser by sliding it onto the supports and pin at the bottom, then push the **PUSH** symbol fully in until it clicks into place.

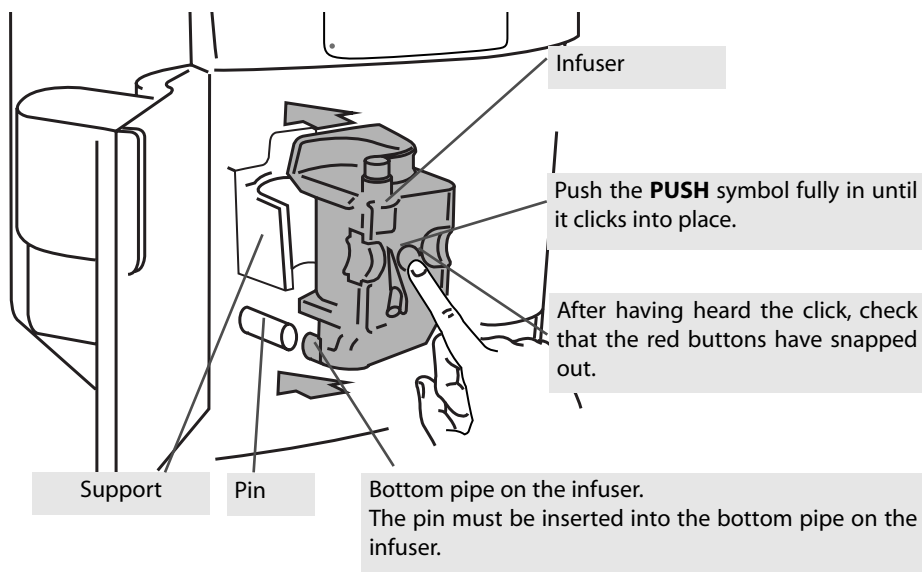

Check that the two red buttons have snapped out, otherwise the door cannot be closed.

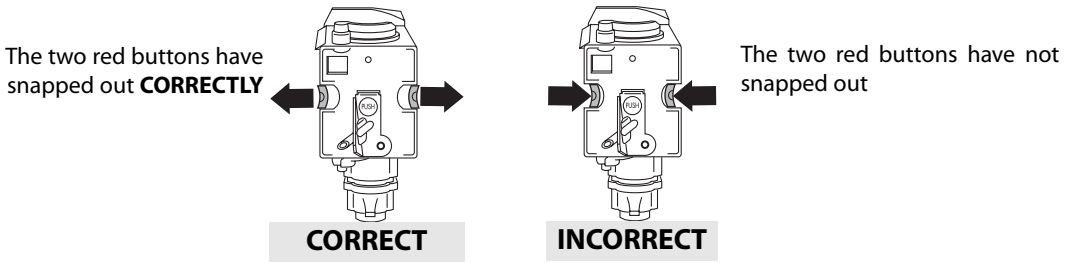

- replace the drip tray, complete with the grounds container;
- close the service door.

NOTE 1: If the infuser is not inserted correctly until it clicks into place and the two red buttons have not snapped out, the service door cannot be closed.

NOTE 2: if it is hard to insert the infuser, before inserting it, squeeze to size by pressing it vigorously from above and below at the same time, as shown in Figure.

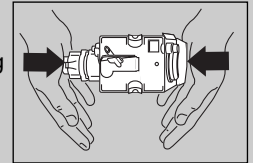

NOTE 3: If it is still hard to insert the infuser, leave it out of the appliance, close the service door, unplug from the mains, then plug in again. Wait for all the lights to go off after the self-diagnosis, then open the door and replace the infuser.

16.3 Cleaning the milk container

Proceed as follows:

- Remove the milk spout (1) and intake tube (2).
- Remove the pointer (3) by pulling it outwards (see figure)
- Wash all the components thoroughly with hot water and washing-up liquid. Make sure there are no milk residues inside the two holes in the lid of the milk container indicated by the arrows in the figure or in the groove (4) in the pointer.
- Replace the pointer, intake tube and milk spout, after making sure they are not clogged with milk residues.

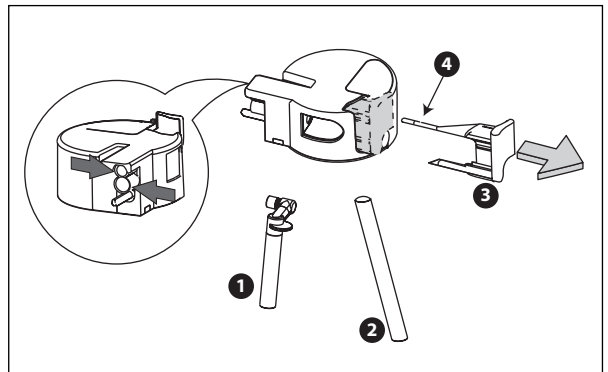

17 CHANGING AND SETTING THE MENU PARAMETERS



After pressing the button ① when the appliance is ready, you can use the internal menu to modify the following parameters and functions:

- Clock
- Auto-start time
- Auto-start
- Descaling process
- Coffee temperature
- Length of time the appliance remains on (turn off after)
- Water hardness
- Factory default values
- Washing process
- Beep ON/OFF



Note: the last line of the display is the guide to the function buttons

17.1 Setting the clock

To set the clock, proceed as follows:

- Press the **P** button, then press the  button (corresponding to the  symbol flashing on the display) repeatedly until the menu arrow is on:



 *CLOCK 00:00*

- Press the  button (corresponding to the **SET** symbol flashing on the display) to set the time on the clock.(If you hold the button down, the time is changed rapidly).
- Press the **OK** button to confirm the value;
- Press the **P** button (corresponding to the **ESC** symbol flashing on the display) to exit programming mode or  to change other parameters.



Note: to display the time with the appliance off, press any button. The time will be displayed for five minutes.

17.2 Setting auto-start time

This enables the time the appliance will come on automatically and be ready for use to be programmed.

- Make sure the clock on the appliance is set as described above.
- Press the **P** button then press  (corresponding to the  symbol flashing on the display) repeatedly until the menu arrow is on:

STARTTIME 00:00

- Press the  button (corresponding to the **SET** symbol flashing on the display) to set the automatic start up time.(If you hold the  button down, the time is changed rapidly).
- Press the **OK** button to confirm the value;
- Press **SET** button again and the appliance displays the message:

 *AUTO-START NO*

Press the  button (corresponding to the **SET** symbol flashing on the display) to modify the function (the appliance displays:“*AUTO-START YES*”);

- Press the **OK** button to activate auto-start;
- Press the **P** button (corresponding to the **ESC** symbol flashing on the display) to exit programming mode or  to change other parameters.

NOTE: when auto-start time is set, the symbol  appears alongside the time on the display.

17.3 Descale

Over time, the continuous heating up of the water used to make the coffee leads to lime scale building up in the inner circuits of the appliance.

When the message:

DESCALE

flashes on the display, you should perform the descale cycle.

Proceed as follows:

- make sure the appliance is ready.
- press the **P** button (the light over the button comes on) then press the  button repeatedly until the appliance displays:

 *DESCALE NO*

- Press the  button (corresponding to the **SET** symbol flashing on the display) and the appliance will display:

 *DESCALE YES*

- Press the **OK** button to start the descale programme.
- Empty the tank and pour in the contents of one bottle (125 ml) of DURGOL descaler plus **one litre of water**.

For subsequent descaling, use descaler of the same type and brand as supplied (available from technical service centres authorised by the manufacturer).

- attach the water spout to the nozzle;
- place a container with a minimum capacity of 1.5 litres under the hot water spout (Fig. 3);

- press the **OK** button. Descaler runs off from the hot water spout into the container below. The appliance displays:

APPLIANCE IN DESCALE

- the descale programme automatically performs a series of run offs and pauses to remove lime scale deposits from inside the coffee maker.
- After about 30 minutes, the appliance displays:

RINSING FILL TANK

The appliance must now be rinsed through to eliminate residues of descaling solution from inside the appliance. Proceed as follows:

- empty the water tank, rinse and fill with clean water.
- Reposition the tank.
- Empty the full container and then put it back under the hot water spout.
- Press the **OK** button. Hot water is run off from the spout into the container below and the appliance displays:

RINSING

- When the water tank is empty, the appliance displays the message:

RINSING COMPLETE PRESS OK



- Press the **OK** button and refill the water tank with clean water.
- The descale programme is now terminated and the appliance is ready to make coffee again.

NOTE: if the descaling cycle is interrupted before completion, the appliance continues to display the descale message and the programme must be started again from the beginning. Empty the water tank, rinse, fill with clean water and run off a cup of hot water.



IMPORTANT FAILURE TO DESCALE THE APPLIANCE REGULARLY INVALIDATES THE GUARANTEE.

17.4 Changing coffee temperature

To change the temperature of the coffee, proceed as follows:

- Press the **P** button, then press the  button (corresponding to the  symbol flashing on the display) repeatedly until the menu arrow is on:



 *HIGH TEMPERATURE*

- Press the  button (corresponding to the **SET** symbol flashing on the display) until the appliance displays the required coffee temperature.
Note: to obtain hotter coffee, see also section 6, note 3, page 28.
- Press the **OK** button to confirm the temperature selected;
- Press the **P** button (corresponding to the **ESC** symbol flashing on the display) to exit programming mode or  to change other parameters.



17.5 Changing the length of time the appliance remains on

The appliance is factory preset to go off automatically one hour after the last coffee has been made.

The number of hours the appliance remains on (max. 3) can be increased as follows:

- Press the **P** button, then press the  button (corresponding to the  symbol flashing on the display) repeatedly until the menu arrow is on:

 *OFF AFTER 1 HOUR*

- Press the  button (corresponding to the **SET** symbol flashing on the display) to change the number of hours the appliance remains on.
- Press the **OK** button to confirm the value;
- Press the **P** button (corresponding to the **ESC** symbol flashing on the display) to exit programming mode or  to change other parameters.



17.6 Setting water hardness

The descale message is displayed after the appliance has been operated for a factory set period of time calculated on the basis of the maximum quantity of lime scale which may be contained in the water used. If necessary, this period of operation can be extended, making descaling less frequent, by programming the appliance based on the actual lime content in the water used.

Proceed as follows:

- remove the "Total Hardness Test" strip (enclosed on page 2) from its packaging then dip it fully in the water for a few seconds and remove.

After about a minute, 1, 2, 3 or 4 red squares develop.

- Press the **P** button, then press the  button (corresponding to the flashing  symbol on the display) repeatedly until the menu arrow is on:

 WATER HARDNESS 4

- Press the  button (corresponding to the **SET** symbol flashing on the display) repeatedly until the number coincides with the number of red squares on the test strip (for example, **if there are 3 red squares on the test strip**, press the button until WATER HARDNESS 3 is displayed).



- Press the OK button to confirm the value.

The coffee maker is now programmed to provide the descaling warning when necessary, based on the actual hardness of the water.

- Press the **P** button (corresponding to the **ESC** symbol flashing on the display) to exit programming mode or  to change other parameters.

17.7 Resetting factory default settings (reset)

If you change the original values, the factory default values can be reset as follows:

- Press the **P** button, then press the  button (corresponding to the  symbol flashing on the display) repeatedly until the menu arrow is on:

 RESET TO DEFAULT NO

- Press the  button (corresponding to the **SET** symbol flashing on the display) and the appliance displays *RESET TO DEFAULT YES*;

- Press the **OK** button to reset the factory default values;



- Press the **P** button (corresponding to the **ESC** symbol flashing on the display) to exit programming mode or  to change other parameters.

- The appliance is now reset to the factory default settings and the READY message is displayed.

17.8 Washing process

This function can be used by technical service personnel only.

17.9 Beep ON/OFF (activates and deactivates the beep)

- Press the **P** button, then press the  button (corresponding to the  symbol flashing on the display) repeatedly until the menu arrow is on:

 BEEP ON

- Press the  button (corresponding to the **SET** symbol flashing on the display) and the appliance will display *"BEEP OFF"*;

- Press the **OK** button to turn the beep off;



- Press the **P** button (corresponding to the **ESC** symbol flashing on the display) to exit programming mode or  to change other parameters.

- The appliance is now set not to emit any Beep and displays the message READY.

18 CHANGING THE LANGUAGE







To change the language, press the OK button for at least 5 seconds until the appliance displays the installation message in various languages. Select the required language and press **OK** for 3 seconds (as described in paragraph 4.1).

19 MEANING OF MESSAGE DISPLAYED AND WHAT TO DO

MESSAGE	MEANING	WHAT TO DO
<i>FILL TANK</i>	<ul style="list-style-type: none"> The water tank is empty or is positioned incorrectly. The tank is dirty or encrusted with lime scale. 	<ul style="list-style-type: none"> Fill the water tank as described in paragraph 4.2 and insert it fully. Rinse or descale the tank.
<i>GROUND TOO FINE ADJUST MILL AND INSERT WATER SPOUT AND PRESS OK</i>	<ul style="list-style-type: none"> The coffee runs off too slowly. The appliance cannot make coffee 	<ul style="list-style-type: none"> Turn the grinding regulator (fig. 11) one click towards the number 7 (see section 8). Insert the hot water spout, press the  button and run off water from the spout for a few
<i>EMPTY GROUNDS CONTAINER</i>	<ul style="list-style-type: none"> The grounds container is full or missing. 	<ul style="list-style-type: none"> Empty the grounds container and clean as described in section 6, note 7, then replace.
<i>INSERT GROUNDS CONTAINER</i>	<ul style="list-style-type: none"> After cleaning, the grounds container has not been replaced. 	<ul style="list-style-type: none"> Open the service door and insert the grounds container.
<i>ADD PRE-GROUND COFFEE</i>	<ul style="list-style-type: none"> With the function selected, the pre-ground coffee has not been poured into the funnel. 	<ul style="list-style-type: none"> Add the ground coffee as described in paragraph 9.
<i>FILL BEANS CONTAINER</i>	<ul style="list-style-type: none"> The coffee beans have run out. If the coffee grinder is very noisy, this means a small stone in the coffee beans has blocked the mill. 	<ul style="list-style-type: none"> Fill bean container Contact an authorised De'Longhi service centre.
<i>DESCALE</i>	<ul style="list-style-type: none"> This indicates the presence of lime scale in the appliance. 	<ul style="list-style-type: none"> The descaling procedure, described in paragraph 17.3, needs to be performed as soon as possible.
<i>PRESS  +SET</i>	<ul style="list-style-type: none"> After cleaning, the infuser has probably been left out of the coffee maker. 	<ul style="list-style-type: none"> Leave the service door closed and the infuser out of the appliance, then follow the instructions displayed.
<i>CLOSE DOOR</i>	<ul style="list-style-type: none"> The service door is open 	<ul style="list-style-type: none"> If the service door cannot be closed, check that the infuser is inserted correctly (paragraph 16.2 - note 1)
<i>INSERT WATER SPOUT</i>	<ul style="list-style-type: none"> The  button has been pressed and the hot water spout has not been inserted. 	<ul style="list-style-type: none"> Insert the hot water spout (fig. 4)
<i>INSERT INFUSER ASSEMBLY LESS COFFEE</i>	<ul style="list-style-type: none"> After cleaning, the infuser has probably been left out of the coffee maker. The ground coffee funnel is clogged. Too many coffee beans or too much ground coffee has been added. 	<ul style="list-style-type: none"> Insert the infuser, see paragraph 16.2 Empty the funnel with the help of a knife, as described in paragraph 9 note 5 (Fig. 16). Select a milder taste or reduce the quantity of ground coffee, then run off the coffee again.
<i>GENERIC ALARM</i>	<ul style="list-style-type: none"> The inside of the appliance is very dirty. 	<ul style="list-style-type: none"> Clean the inside of the appliance thoroughly, as described in paragraph 16.2. If the message is still displayed after cleaning, contact a service centre.

20 PROBLEMS TO BE RESOLVED BEFORE CALLING THE SERVICE CENTRE

If the appliance is not working and an alarm light is on, the causes of the malfunction can be identified and resolved by referring to section 19. If, on the other hand, no alarm light is on, run the following checks before calling the service centre.

PROBLEM	CAUSE	SOLUTION
The coffee is not hot	<ul style="list-style-type: none"> The cups have not been preheated. The infuser is too cold 	<ul style="list-style-type: none"> Heat the cups by rinsing them in hot water or leaving them to rest for at least 20 minutes on the cup warmer tray on the lid (see section 6, note 3). Heat the infuser by pressing the  button (fig. 12) before making the coffee (see section 6, note 3).
The coffee is not creamy enough	<ul style="list-style-type: none"> The coffee is ground too coarsely Wrong type of coffee 	<ul style="list-style-type: none"> Turn the grinding adjustment knob one click towards the number 1 (see section 8). Use a type of coffee for espresso coffee makers.
The coffee runs out too slowly.	<ul style="list-style-type: none"> The coffee is ground too finely. 	<ul style="list-style-type: none"> Turn the grinding adjustment knob (fig. 12) one click towards the number 7 (section 8).
The coffee runs out too quickly.	<ul style="list-style-type: none"> The coffee is ground too coarsely. 	<ul style="list-style-type: none"> Turn the grinding adjustment knob one click towards the number 1 (see section 8).
The coffee does not come out of one of the spouts.	<ul style="list-style-type: none"> The spout holes are blocked. 	<ul style="list-style-type: none"> Scrape the remains of dry coffee accumulated with a needle (Fig. 29).
When the  and  buttons are pressed, the appliance does not deliver coffee, but only water.	<ul style="list-style-type: none"> The ground coffee may be blocked in the funnel. 	<ul style="list-style-type: none"> Remove the ground coffee inside the funnel using a knife (see note 5, section 9). Then clean the infuser and the inside of the appliance (see description in paragraph 16.2)
When the  button is pressed, the appliance does not come on.	<ul style="list-style-type: none"> The appliance is not plugged in or the main switch is not switched on. 	<ul style="list-style-type: none"> Check that the power cable is plugged into the mains socket or switch on the main switch.
The infuser cannot be removed for cleaning.	<ul style="list-style-type: none"> The appliance is on. The infuser can only be removed if the appliance is off 	<ul style="list-style-type: none"> Turn the appliance off and remove the infuser (see paragraph 16.2). IMPORTANT: the infuser can only be removed if the appliance is off. Attempting to remove the infuser with the appliance on will risk causing damage.
Pre-ground coffee is being used (not beans) and the appliance does not deliver coffee.	<ul style="list-style-type: none"> Too much ground coffee has been added. The  button has not been pressed and the appliance has used both the ground coffee added and the coffee ground by the grinder. Ground coffee has been added when the appliance is off. 	<ul style="list-style-type: none"> Remove the infuser and thoroughly clean the inside of the appliance, as described in paragraph 16.2. Repeat the operation using a maximum of 1 measure of ground coffee. Thoroughly clean the inside of the appliance, as described in paragraph 16.2. Repeat the operation, first pressing the  button as described in section 9. Remove the infuser and thoroughly clean the inside of the appliance, as described in paragraph 16.2. Repeat the operation, but switch the appliance on first.

PROBLEM	CAUSE	SOLUTION
The coffee does not come out of the spouts, but rather around the service door.	<ul style="list-style-type: none"> • The holes in the spouts are clogged with dry coffee. • The mobile drawer inside the service door is blocked and cannot swing. 	<ul style="list-style-type: none"> • Scrape the holes with a needle (see paragraph 16.1, Fig. 29). • Thoroughly clean the mobile drawer, particularly near the hinges to ensure they are free to swing smoothly.
The milk does not run out of the milk spout.	<ul style="list-style-type: none"> • The intake tube is not inserted or is inserted incorrectly. 	<ul style="list-style-type: none"> • Insert the intake tube in the rubber washer in the milk container lid (fig. 19).
The milk is not well frothed.	<ul style="list-style-type: none"> • The milk container lid is dirty. 	<ul style="list-style-type: none"> • Clean the milk lid as described in paragraph 16.3.
The milk contains bubbles or squirts out of the milk spout.	<ul style="list-style-type: none"> • The milk is not cold enough or is not skimmed or semi-skimmed. 	<ul style="list-style-type: none"> • You are recommended to use skimmed or semi-skimmed milk at refrigerator temperature (about 5°C). If you are still not getting the required results, try changing brand of milk.